

cero by Solarlux

cero

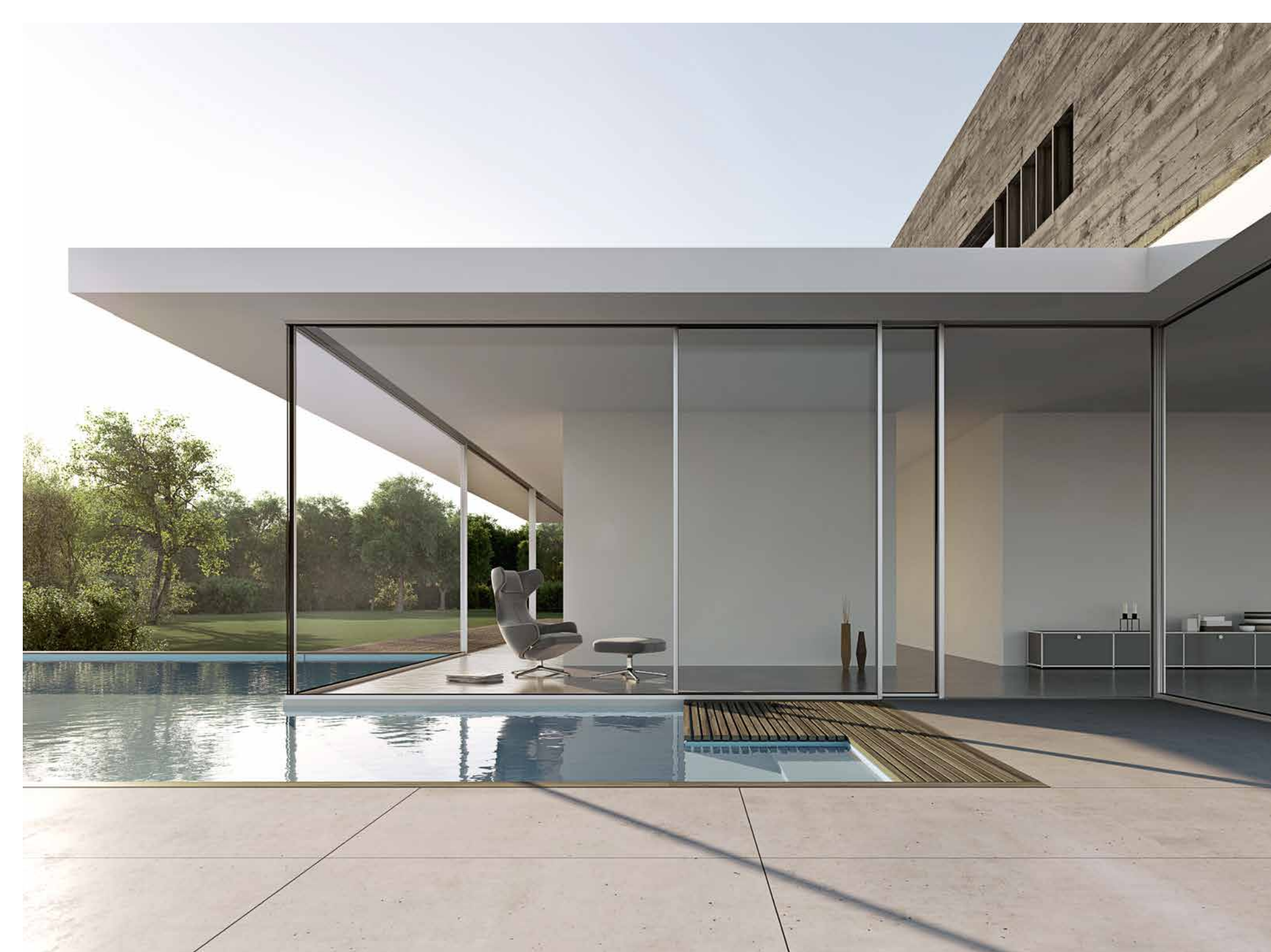

cero by Solarlux

cero opens rooms with extensive glass panels. Impressive transparency dissolves the line between inside and outside. As a brand of Solarlux, the leading supplier in the field of folding glass doors and glass extensions, cero benefits from over 30 years of experience in the field of customised solutions with the guarantee of precision, intelligent technical details, along with their own production, construction management and discerning design, exclusively "made in Germany".

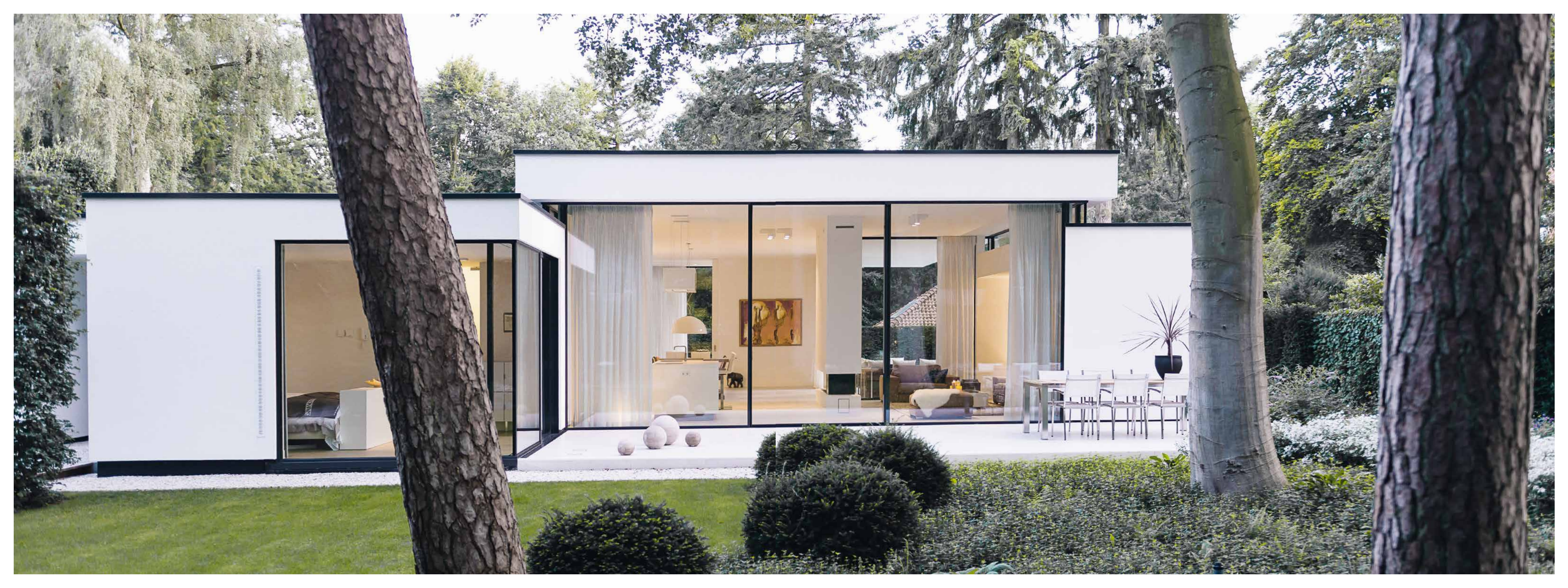

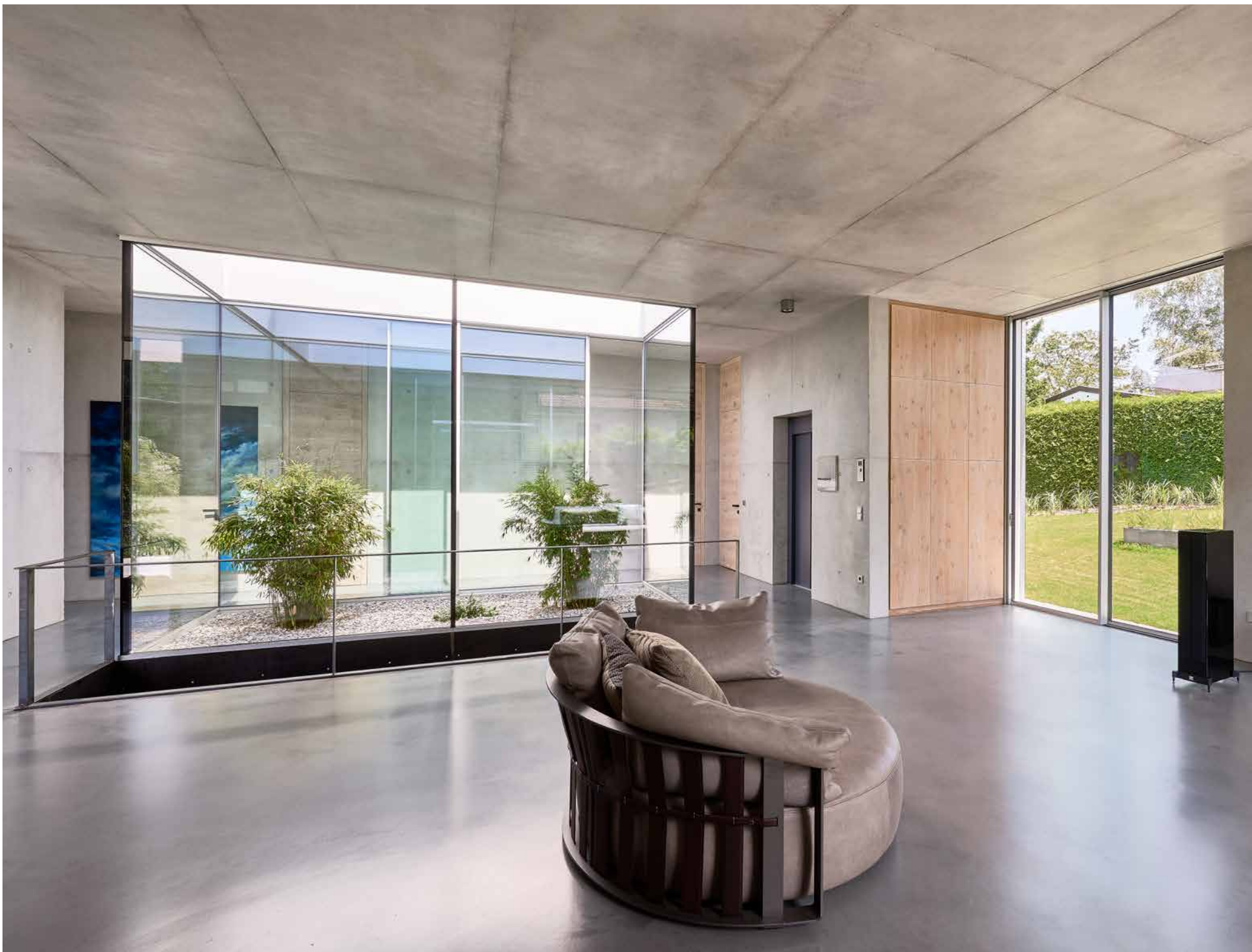

Great design freedom

cero offers every possibility required from architecturally demanding buildings from a constructive and creative point of view. Light, material, space and nature speak for themselves – and the borders between interior and exterior melt away.

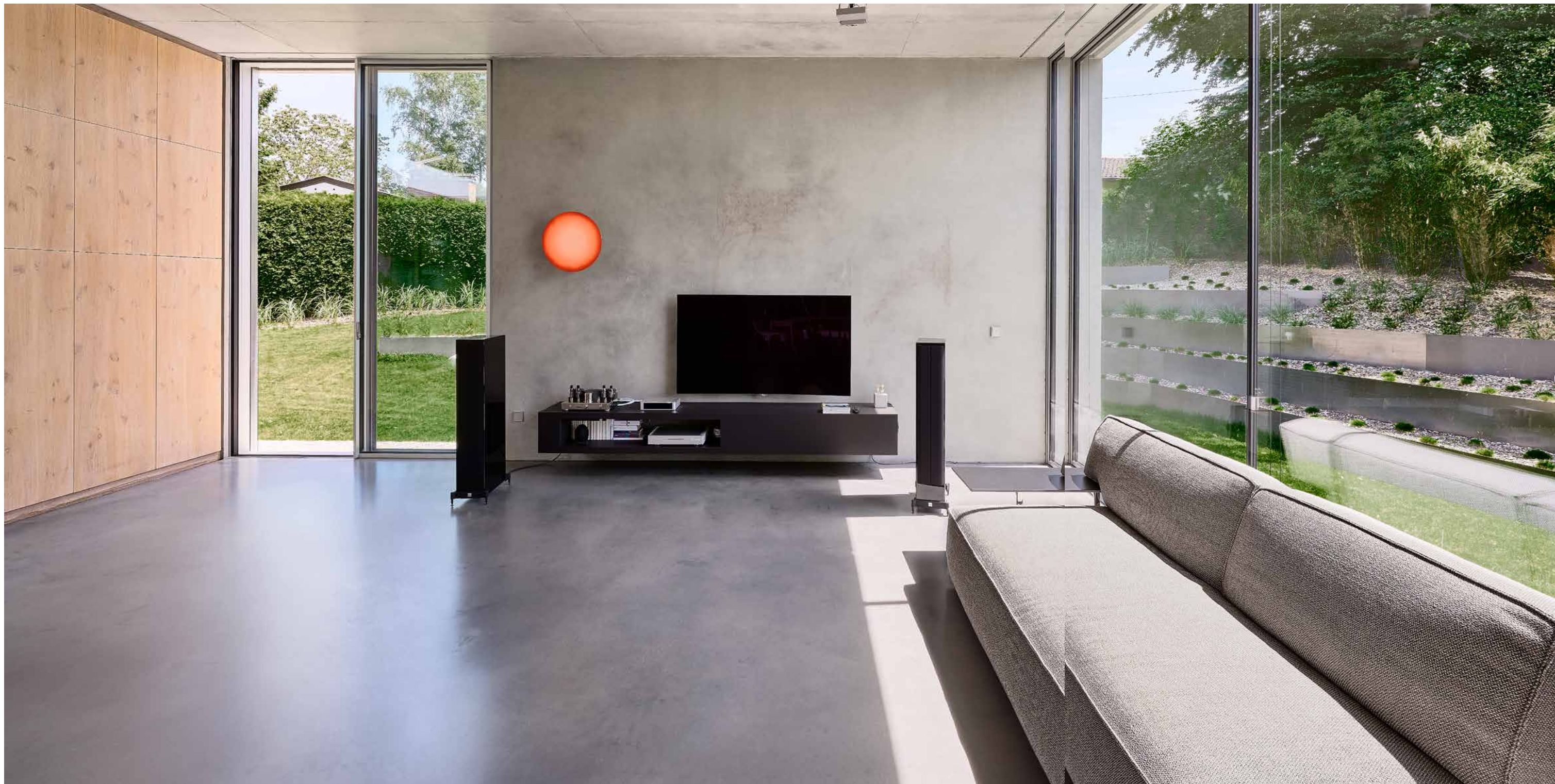



Perfect frames

Narrow frames and sections support the maximum transparency of the elements. A mere 34 mm of profile width gives a symmetrical and minimalist design, emphasised by 98 % glass.





Excellent security

Extremely large glass panels of up to 15 m² put quality and security aspects in special focus. cero is tested and can be certified to the highest security standards (RC2 and RC3). A 2-point rod locking system with adjustable locking points and a hub of 24mm in the upper running and guide rails is standard. It is also possible to fit connections for alarm installations, or reporting systems such as glass-break sensors or position monitors.

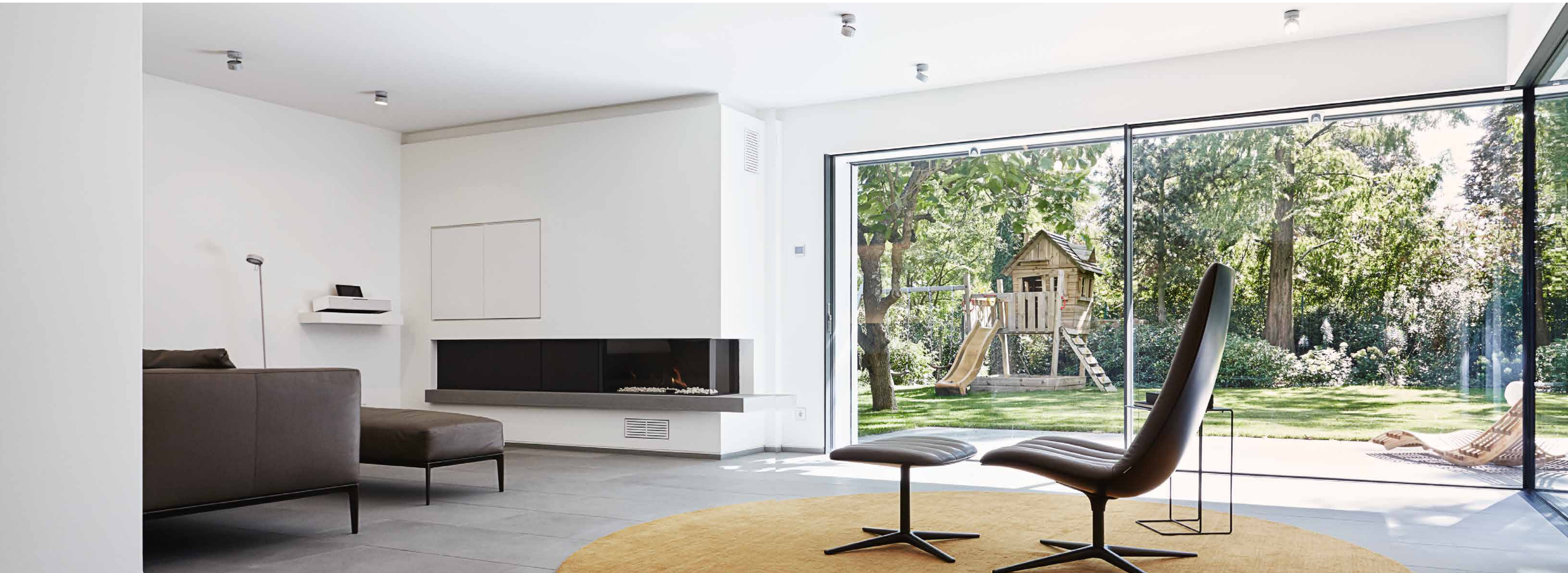



Award-winning design

Along with well-thought-out, constructive and technical details, cero also distinguishes itself through its great design aspirations. This is confirmed by prestigious design prizes awarded by various international juries.

- **Iconic Award** "Best of Best" in the category "Facades"
- **iF Gold Award** in the category "Building Technology"
- **German Design Award** in the category "Building and Elements".



product
best of best





Service you can rely on completely

Those opting for cero also opt for the renowned service reliability of Solarlux. Project planning is carried out by a product-oriented architectural adviser. Project management is executed by experts with vast experience in large, international projects. Trouble-free project execution is ensured by well-practised logistics from our own vehicle fleet and special cranes – and an installation team specialised in the complex installation of large glass panels.

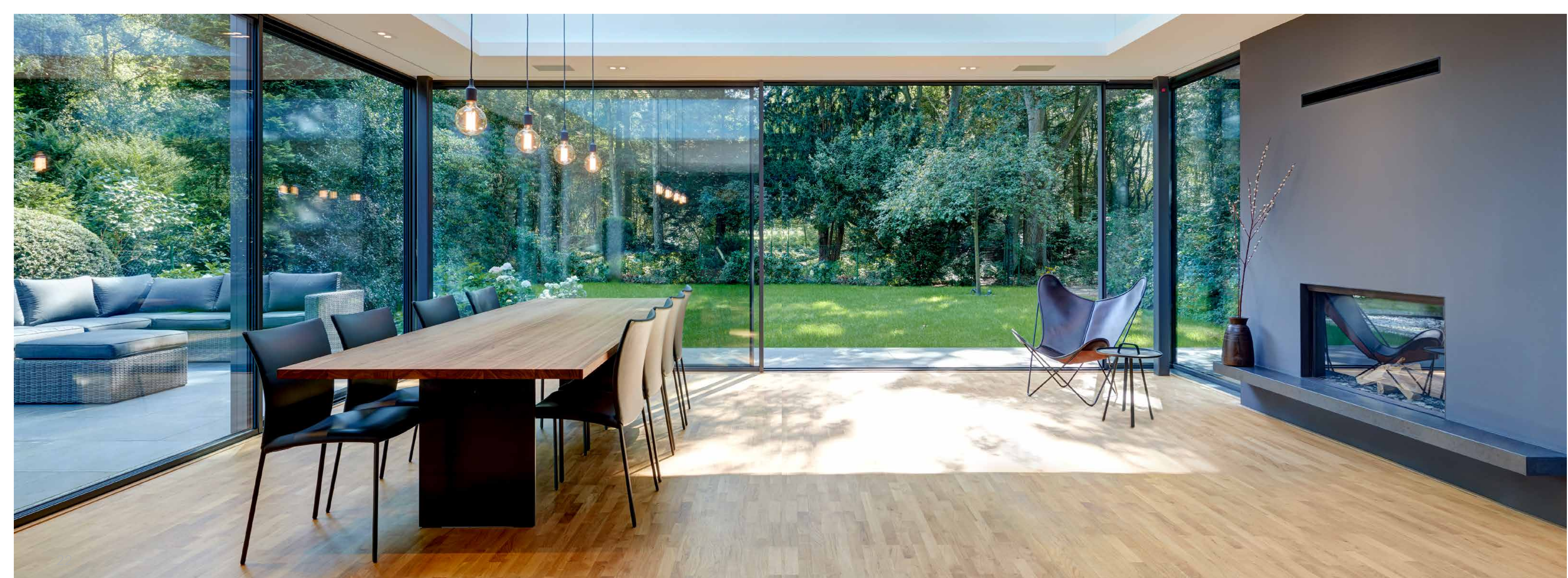

Sophisticated details

cero stands for quality “Made in Germany”. All of the research and development for these large panels is done in our own Research & Development Centre. cero passes all known test requirements with ease.

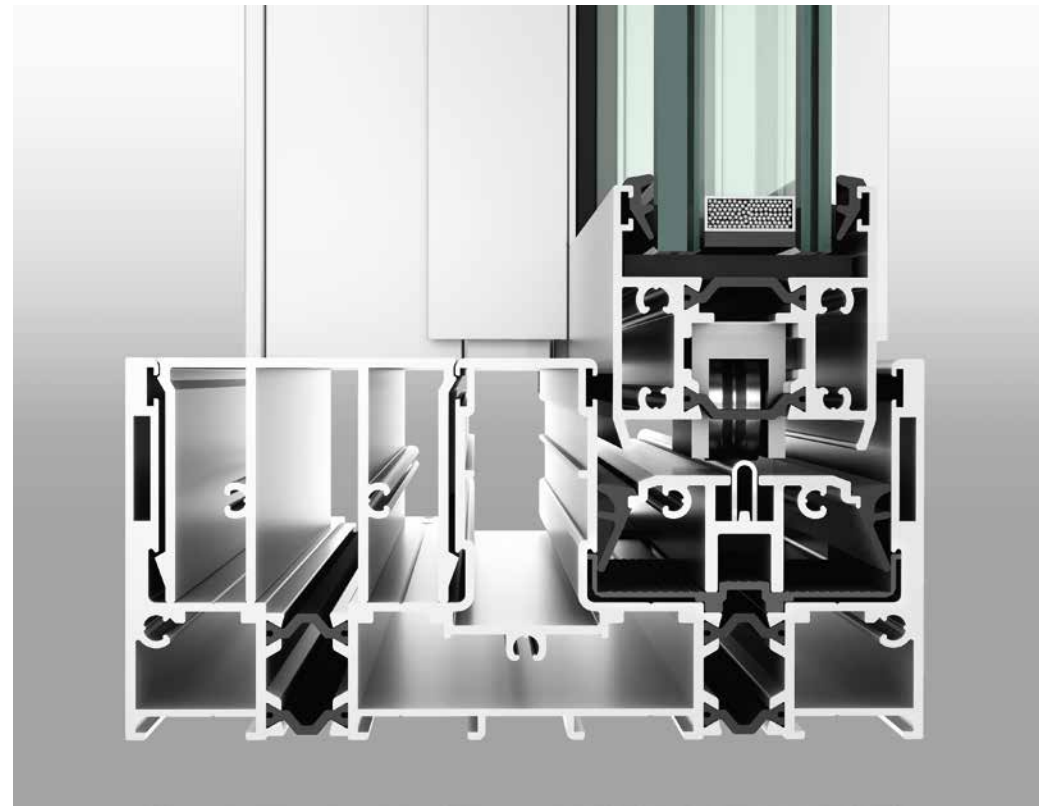

Easy gliding

Stainless steel carriages and rails guarantee easy and low-wear sliding and the integrated stainless steel roller units ensure an even load distribution. An electric panel operation can be installed on request. cero has successfully passed a longevity performance test of 100.000 opening and closing operations.

Intelligent drainage

Draining takes place in a hidden and controlled manner at the lowest level of the frame section. The glass rebate ventilation avoids condensation in the space between the panes.

High-end thermal insulation

cero offers optimal thermal insulation. Its triple toughened glass version achieves U_w values in the region of $0,8 \text{ W/m}^2\text{K}$, suitable for use in passive houses.

Wind and weather protection

cero is tested and certified for air permeability, wind load and driving rain impermeability, thus exceeding the high demands for protection from wind and weather.

Sophisticated details



Integrated security technology

zero can be optimally integrated into an existing, overriding surveillance system. Electro-mechanical locking elements are available on request, with the option of additional lock monitoring using reed contacts.

Motorised drive

The sliding elements can be fitted with a fully automated operating system including electro-mechanical locking and unlocking, which offers the user interdependent control of several panels via a control unit.

Shading

zero offers two options to provide optimum shade for the large glass surfaces: a motor-driven sun-protection system with guide rails to fit the frame, or a built-in slatted sun shade.

Insect protection

Insect protection can be integrated to the frame up to a width of 1,30m. The maximum height is 3m for the zero II and up to 3,5m for the zero III.

Creative freedom



Material

cero offers a large range of design possibilities to suit client requirements. High quality profiles made of aluminium offer durable low maintenance solutions. The A.U.F certification confirms environmentally friendly recycling of the aluminium and sustainability.

Colour

You can order your cero profiles in any colour you want – you can even choose different colours for indoors and outdoors! Choose from an RAL or DB powder coating, an Eloxal coating in accordance with EURAS, or a variety of our specialist colours, which are available on request.

Glazing

Depending on which variant you choose, your cero will come with either triple or double-toughened single-pane safety glass (ESG). You can also opt for functional glazing with burglary and vandalism protection, noise insulation glazing or glazing with a lotus effect.

Handles

cero comes with a high-quality, brushed V4A stainless steel handle as standard to guarantee maximum protection against corrosion.

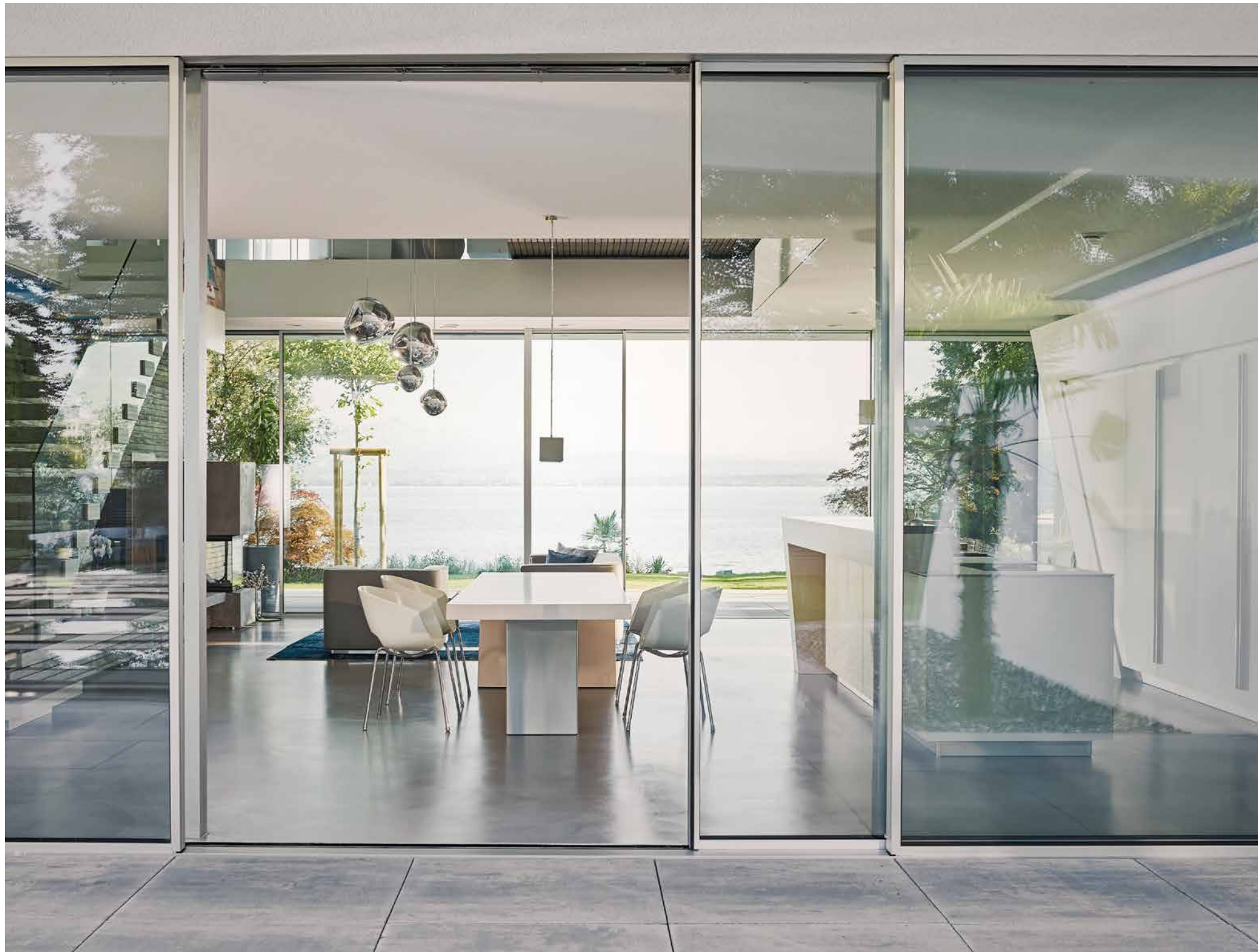

Floor tracks



Accessibility

cero comes with a flush-fitted floor track in order to ensure accessibility in accordance with DIN 18040. The profile depth varies depending on how many tracks you require. For cero II, for example, it would be between 71 mm (single-track), 157 mm (two-track) and 243 mm (three-track).

Aesthetic design options

The new floor track for cero II can be fitted with an insert that matches your interior design, ensuring that your home boasts a harmonious, aesthetically pleasing appearance both inside and out.

Flush-mounted frames

The flush floor tracks can either be installed level with the indoor floor or given a slight ramp on the inside and/or outside.

Suitable for a wide range of applications

The new cero II floor track in particular is perfect for use in shops, hotels, and the gastronomy and retail sectors.

Sample configurations

The range of combination options for zero sliding, fixed and corner elements is almost limitless. They offer an astounding degree of creative freedom in terms of design, and are suitable for any floor plan.

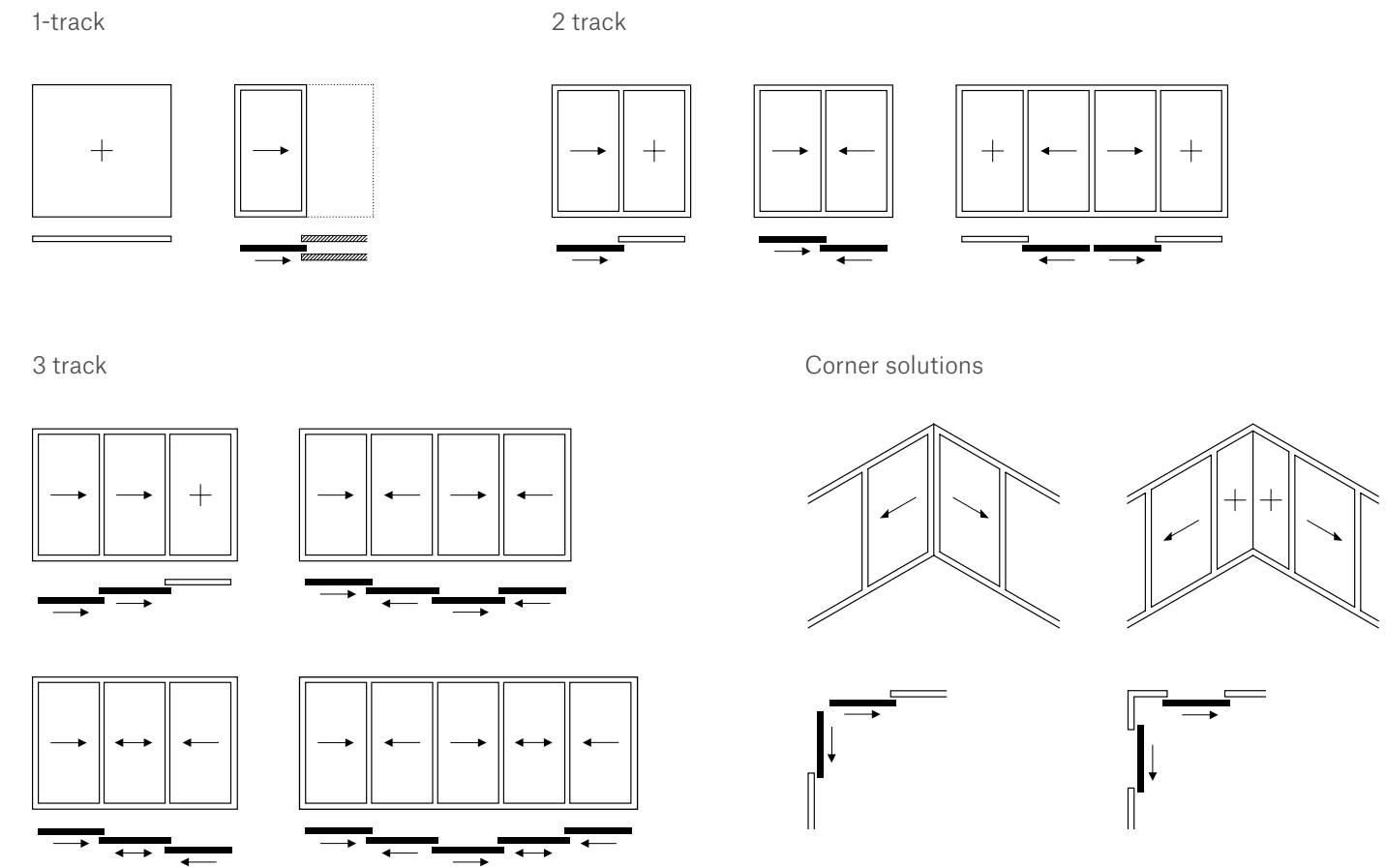

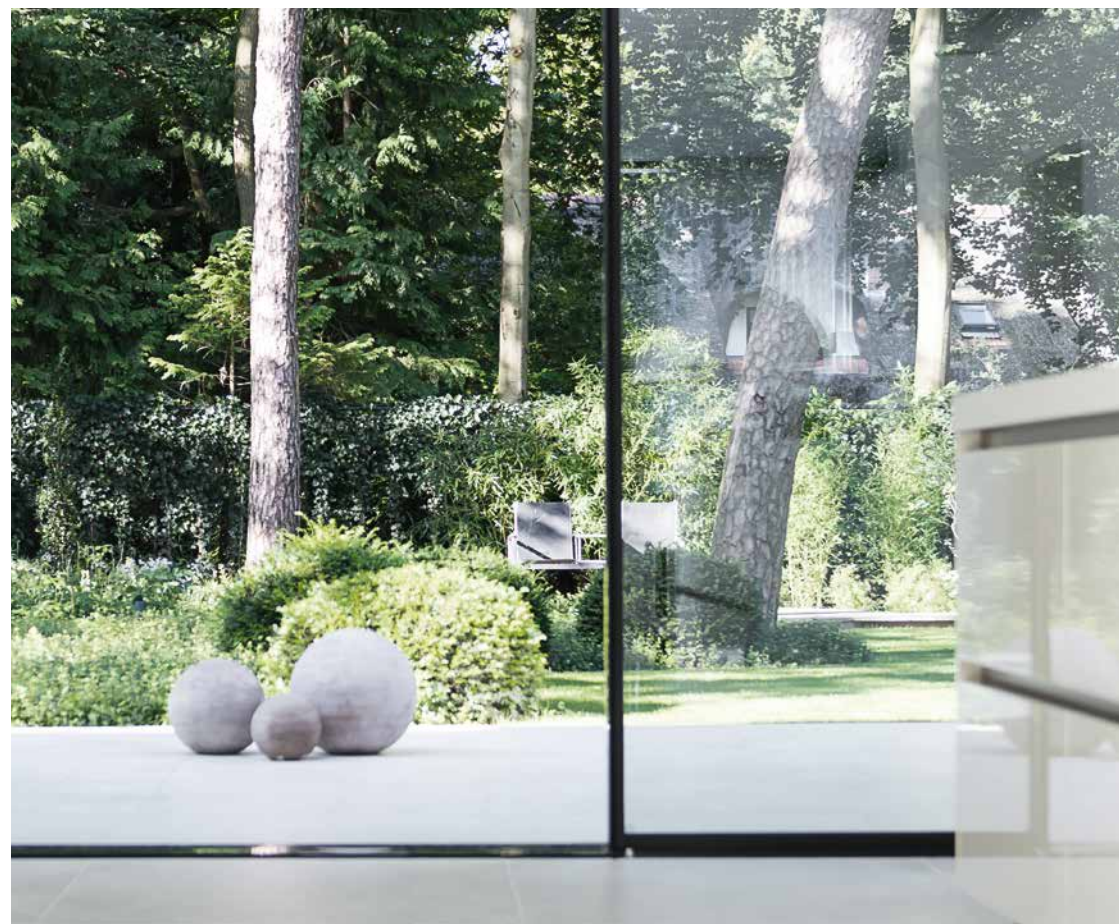

System overview

Arrange a personal consulting session with one of our experienced cero consultants to find out which system is best for your project. The system overview on these pages offers a direct comparison of the key system features at a glance.

	cero I	cero II	cero III
Sliding elements (max. width × max. height)	3 × 4 m / max. panel size 12 m ²	3 × 4 m / max. panel size 12 m ²	4 × 6 m / max. panel size 15 m ²
Fixed glazing (max. width × max. height)	3 × 4 m / max. panel size 12 m ²	3 × 4 m / max. panel size 12 m ²	4 × 6 m / max. panel size 15 m ²
Insulating glass (double)	30–36 mm (ESG)	30–36 mm (ESG)	48–54 mm (ESG) / 50 mm Standard
Daylight/Proportion of glass	98%	98%	98%
Sliding technology	Carriages and slide rails of stainless steel	Carriages and slide rails of stainless steel	Carriages and slide rails of stainless steel
Slide rail/Floor section	barrier-free in accordance with DIN 18040	barrier-free in accordance with DIN 18040	barrier-free in accordance with DIN 18040
Panel weight	max. 600 kg	max. 600 kg	max. 1.000 kg
Visible width	circumferential 34 mm	circumferential 34 mm	circumferential 34 mm
Frame height	0–75 mm	0–75 mm	0–79 mm
Thermal separation	–	In the frame and panel profile	In the frame and panel profile
Thermal insulation value (glass U_g = 1.1 W/m²K)	–	U _w up to 1.35 W/m ² K	–
Thermal insulation value (glass U_g = 0.5 W/m²K)	–	–	U _w up to 0.76 W/m ² K
Heavy rain impermeability up to class	–	9A (EN 1027 / EN 12 208)	E750 (EN 1027 / EN 12 208)
Air permeability up to class	–	4 (EN 1026 / EN 12 207)	4 (EN 1026 / EN 12 207)
Resistance to wind load up to	–	B4 (EN 12 210 / EN 1627)	B3 (EN 12 210 / EN 1627)
Motorisation	–	Electromechanical drive, automatic operation optional	Electromechanical drive, automatic operation optional
Fly protection	–	up to 3.5 m high	up to 3.5 m high

Detail section cero II

cero II is suitable for any application where you need to provide an accessible opening (using a flush-mounted floor track), and comes with double or triple-toughened single-pane safety glass (ESG) as standard.

Vertical section | nts

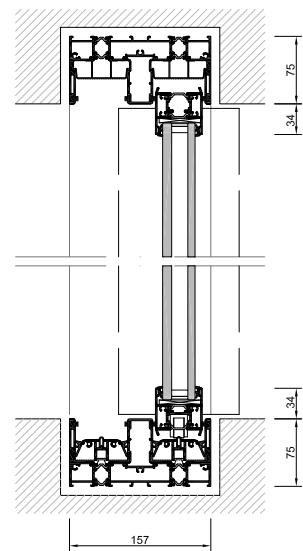

Horizontal section | nts

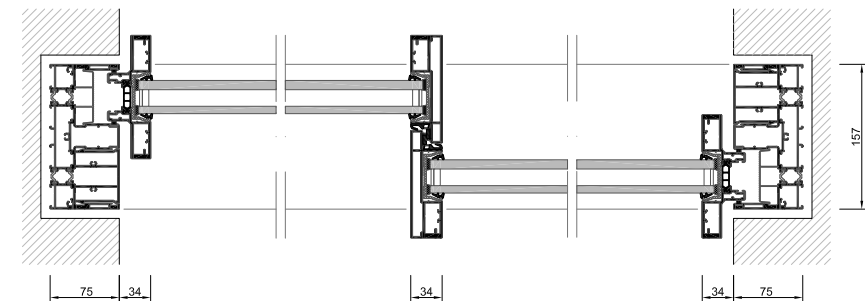

Detail sections cero III

cero III meets challenging demands to provide the lowest possible U_w values and is equipped with triple-toughened single-pane safety glass (ESG) as standard. To meet the highest design requirements, a moveable corner solution and an all-glass corner are also available.

Vertical section | nts

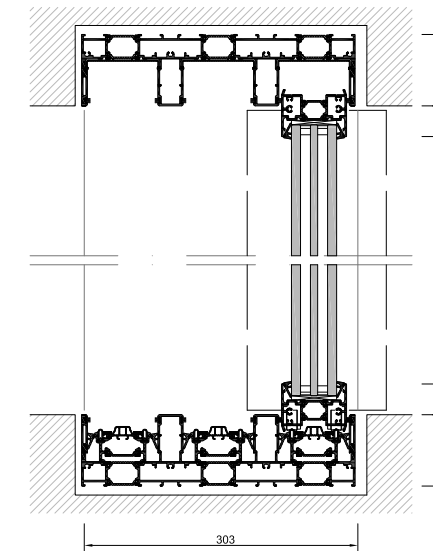

Horizontal section | nts

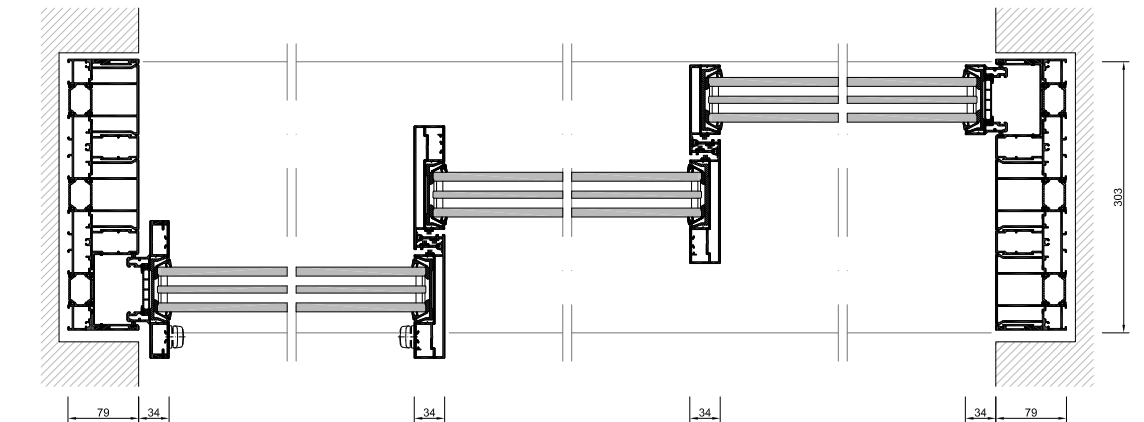





Pentek Pencere Aksesuar San. ve Tic. A.Ő.

Galvano Teknik San. Sit. E Blok No:31
İkitelli OSB BaŐakŐehir 34490 İstanbul - TR

+90 212 549 45 69

info@pentekdograma.com

www.pentekdograma.com

Solarlux GmbH · Industriepark 1 · 49324 Melle · T +49 (0)5422 92710 · info@zero.de · www.zero.systems

zero